

SUBMINIATURE — SEALED

DC Series

Features

- Enclosed switch complying with IP 6K7
- Silicon-free version available
- Models available for operating temperatures up to 120°C
- Rated for currents up to 10 amp at 250VAC
- Range of auxiliary actuators available (can also be retrofitted)
- Various contact materials available, depending on application
- Mechanical life: min. 1 x 10⁶ operations
- Wide variety of connection options

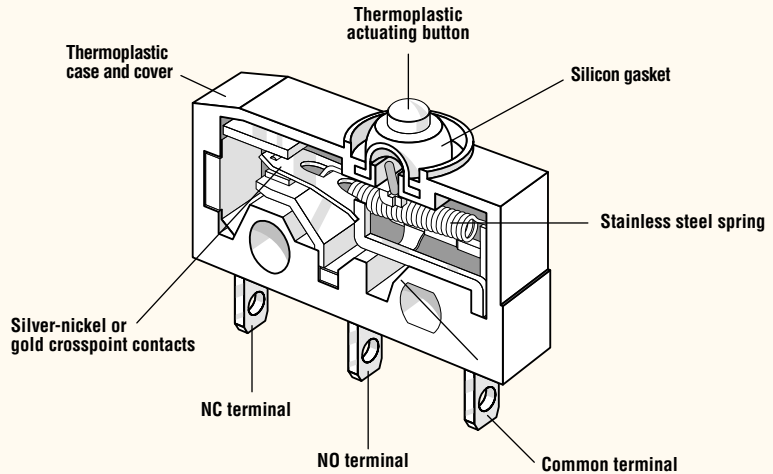

Electrical Ratings

Switch Series	EN61058 Rating	UL1054 Rating	Electrical Life at Rated Load	
			According to EN (Min. Operations)	According to UL (Min. Operations)
DC1	6A, 250V~	5A, 125/250VAC	10,000	6,000
DC2	10(1.5)A, 250V~	10.1A, 125/250VAC; 1/4HP, 125VAC	10,000	6,000
DC3	0.1A, 250V~	0.1A, 125/250VAC	50,000	6,000
DC4	3A, 250V~	3A, 125/250VAC	50,000	6,000

Specifications

Electrical

Temperature Rating: -40° to +85°C / +120°C (without wire leads)
-40° to +85C / +105°C (with wire leads)

Flammability Rating: UL94V-O (PET, PBT)
UL94HB (POM)

Materials

Case: PET / PBT
Actuator: POM (T85), PBT (T120)
Auxiliary Actuator: Stainless Steel or Plastic
Terminals: Silver-Plated Copper-Zinc
Contacts: Silver Alloy (DC3 — Gold Crosspoint)

PBT = Polybutyleneterephthalate • PET = Polyethyleneterephthalate • POM = Polyacetal



Auxiliary Actuators inches (mm)

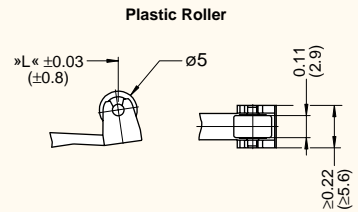
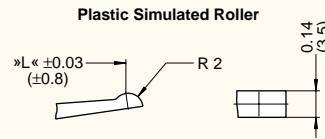
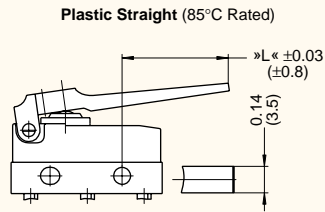
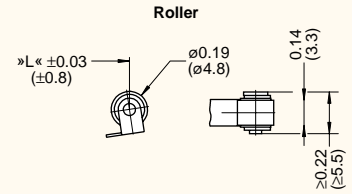
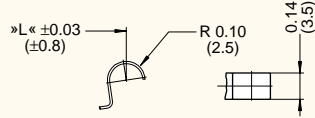
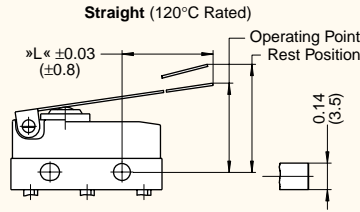

Actuator Specifications

Actuator Code	Switch Type	Maximum Operating Force (cN)		Maximum Pre-Travel inches (mm)		Operating Point inches (mm)		Minimum Over-Travel inches (mm)	Max. Movement Differential inches (mm)		Max. Rest Position inches (mm)	Actuation Length inches (mm)
		DC1, DC3, DC4	DC2	DC1, DC3, DC4	DC2	DC1, DC3, DC4	DC2		DC1, DC3, DC4	DC2		
AA		200	340	0.04 (1.0)	0.04 (1.0)	0.33±0.01 (8.4±0.3)	0.33±0.01 (8.4±0.3)	0.02 (0.6)	0.004 (0.10)	0.004 (0.10)	0.37 (9.3)	—
LB		80	150	0.18 (4.5)	0.20 (5.0)	0.42±0.05 (10.7±1.3)	0.42±0.06 (10.7±1.6)	0.06 (1.5)	0.02 (0.5)	0.03 (0.7)	0.55 (14.0)	0.189 (4.8)
LC		70	120	0.20 (5.0)	0.22 (5.5)	0.44±0.06 (11.1±1.5)	0.44±0.07 (11.1±1.8)	0.06 (1.5)	0.02 (0.6)	0.04 (1.0)	0.59 (15.0)	0.276 (7.0)
LD		<i>forces and travel available upon request</i>										1.654 (42.0)
SB		90	160	0.18 (4.5)	0.20 (5.0)	0.63±0.05 (16.0±1.3)	0.63±0.06 (16.0±1.6)	0.06 (1.5)	0.02 (0.5)	0.03 (0.7)	0.75 (19.0)	0.098 (2.5)
SC		80	130	0.20 (5.0)	0.22 (5.5)	0.65±0.06 (16.4±1.5)	0.65±0.07 (16.4±1.8)	0.06 (1.5)	0.02 (0.6)	0.04 (1.0)	0.79 (20.0)	0.185 (4.7)
SD		<i>forces and travel available upon request</i>										1.563 (39.7)
RB		90	160	0.18 (4.5)	0.20 (5.0)	0.62±0.05 (15.8±1.3)	0.62±0.06 (15.8±1.6)	0.06 (1.5)	0.02 (0.5)	0.03 (0.7)	0.75 (19.0)	0.098 (2.5)
RC		80	130	0.20 (5.0)	0.22 (5.5)	0.64±0.06 (16.2±1.5)	0.64±0.07 (16.2±1.8)	0.06 (1.5)	0.02 (0.6)	0.04 (1.0)	0.79 (20.0)	0.185 (4.7)
RD		<i>forces and travel available upon request</i>										1.563 (39.7)
WB		68	115	0.18 (4.5)	0.18 (4.5)	0.44±0.06 (11.1±1.5)	0.44±0.06 (11.1±1.5)	0.08 (2.0)	0.02 (0.6)	0.02 (0.6)	0.59 (15.0)	0.276 (7.0)
WC		50	85	0.24 (6.0)	0.24 (6.0)	0.48±0.07 (12.2±1.8)	0.48±0.07 (12.2±1.8)	0.12 (3.0)	0.03 (0.8)	0.03 (0.8)	0.67 (17.0)	0.551 (14.0)
VB		73	125	0.18 (4.5)	0.18 (4.5)	0.47±0.06 (11.9±1.4)	0.47±0.06 (11.9±1.4)	0.08 (2.0)	0.02 (0.6)	0.02 (0.6)	0.59 (15.0)	0.220 (5.6)
ZB		73	125	0.18 (4.5)	0.18 (4.5)	0.63±0.06 (16.0±1.4)	0.63±0.06 (16.0±1.4)	0.06 (1.5)	0.02 (0.6)	0.02 (0.6)	0.75 (19.0)	0.205 (5.2)



Dimensions inches (mm)

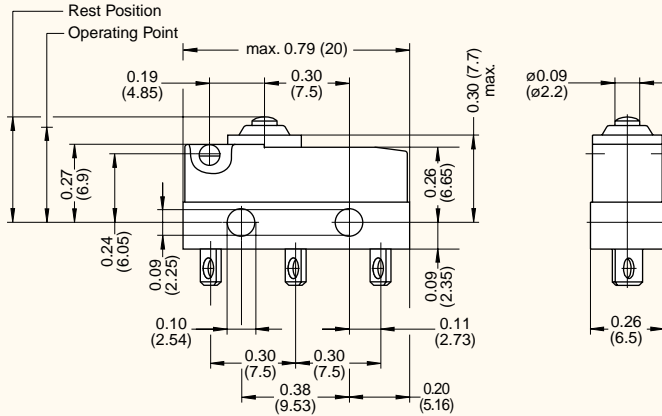

Model with Connecting Leads

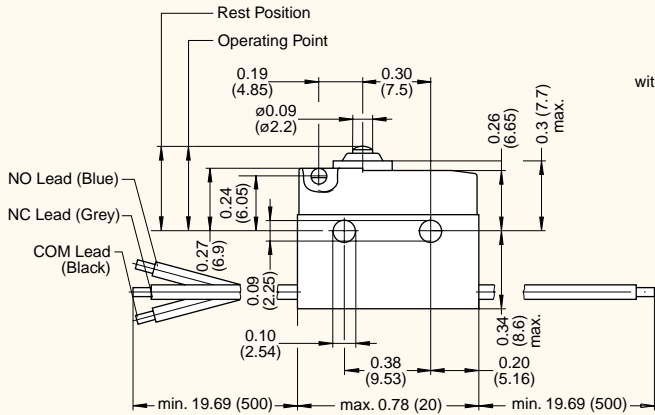

Special Model Available
with Tail Pedestal on Request

Cut-out

Type A



Type B

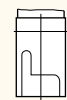

Terminal Options inches (mm)

QC
0.11 x 0.02 (2.8 x 0.5)
Max. 30° Twisted

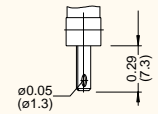

Solder
Short Max. 30° Twisted

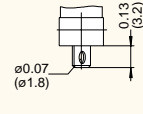

PCB
0.05 x 0.02 (1.3 x 0.5)
Max. 30° Twisted

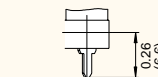

PCB
0.02 x 0.02 (0.6 x 0.5)
Max. 30° Twisted

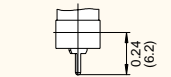

PCB
0.02 x 0.02 (0.6 x 0.5)
RH Side w/o Location Pins

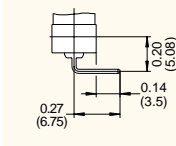

PCB
0.02 x 0.02 (0.6 x 0.5)
RH Side with Location Pins

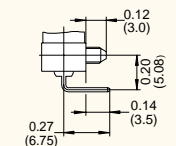

Top Down View of
Lateral Terminals

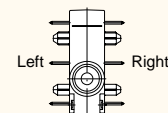

Drilling Pattern
for PCB Terminals
0.05 x 0.02 (1.3 x 0.5)

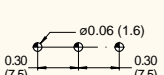

PCB
0.02 x 0.02 (0.6 x 0.5)
LH Side w/o Location Pins

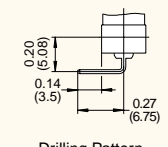

PCB
0.02 x 0.02 (0.6 x 0.5)
LH Side with Location Pins

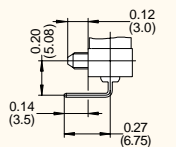

Drilling Pattern
for PCB Terminals
with Location Pins
0.05 x 0.02 (0.6 x 0.5)

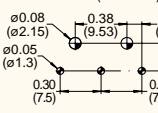

Drilling Pattern
for Lateral/Underside PCB
Terminals w/o Location Pins
0.05 x 0.02 (0.6 x 0.5)
Max. 30° Twisted

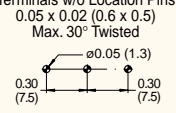

Ordering Information

DC		3
Series/Prefix		
Code	UL Rating	EN 61058 Rating
1	5A, 125/250VAC	6A, 250V~
2	10.1A, 125/250VAC 1/4HP, 125VAC	10(1.5)A, 250V~
3	0.1A, 125/250VAC	0.1A, 250V~
4 ⁴	3A, 250VAC	3A, 250V~

Contact Configuration			
+85°C Operating Temp		+105°/120°C Operating Temp	
Code		Code	
E	SPST NO	A	SPST NO
F	SPST NC	B	SPST NC
G	SPDT	C	SPDT

Notes:

Wire leads 500mm min. (approximately 20" long)

- Only available with terminal configuration 1.
- +85°C rated only.
- Only available with DC1, DC3 and DC4.
- Rating code 4 only as lead-version — leads 0.5mm².
- Wire versions only rated to +105°C.
- Only available with terminal configuration 3 or 4.

Code	Terminal Type inches (mm)	Notes
A	Short Solder	1
B	0.02" (0.5") Leads (No UL)	5, 9
C	0.03" (0.75") Leads (No UL)	5
H	0.05 x 0.02 (1.3 x 0.5) PCB	1
K	0.02 x 0.02 (0.6 x 0.5) PCB	1, 7
L	0.11 x 0.02 (2.8 x 0.5) QC	1
N	Without Leads (Type B)	6
P	Without Leads (Type A)	6
Q	Without Leads (No Cut-Out)	8
S	Welding	1
T	Leads, 20 AWG	3, 11
U	Leads, 22AWG	9, 11
Only Available in North America		
D	Leads 18 AWG (UL Only)	5, 8, 10
E	Leads 16 AWG (UL Only)	5
M	Leads 20 AWG (UL Only)	3, 5

- Only available with terminal configuration 1, 6, 7, 8 or 9.
- Only available with terminal configuration 5.
- Only available with DC3 and DC4.
- Not available with DC2.
- Not available in North America.

3		L	C		
Code	Actuator Type	Code	Actuation Length inches (mm)		
		A	B	C	D
AA	Button only	—	—	—	—
L	Lever	—	0.189 (4.8)	0.276 (7.0)	1.654 (42.0)
R	Roller	—	0.098 (2.5)	0.185 (4.7)	1.563 (39.7)
S	Simulated Roller	—	0.098 (2.5)	0.185 (4.7)	1.563 (39.7)
V ²	Plastic Sim. Roller	—	0.220 (5.6)	—	—
W ²	Plastic Straight	—	0.276 (7.0)	0.551 (14.0)	—
Z ²	Plastic with Roller	—	0.205 (5.2)	—	—

Code	Terminal Configuration
1	30° Twisted
3	Leads on Actuator Side
4	Leads on Opposite Side from Actuator
5	Leads Attached to Underside
6	PCB Terminals Right-hand Side
7	PCB Terminals Left-hand Side
8	PCB Terminals Right-hand Side with Location Pins
9	PCB Terminals Left-hand Side with Location Pins