

**Honeywell**

**ENGLISH**

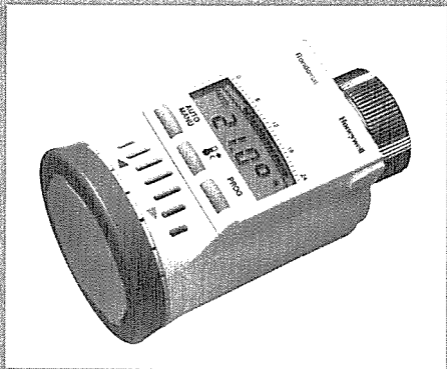

**Rondostat**  
Electronic Thermostat

## Ready for operation in three steps...

1. Insert the batteries
2. Set date and time
3. Mount the thermostat

That's all!

## Check after opening

The **Rondostat** packaging should contain:

- a control element without batteries (1)
- a valve attachment with adjusting dial (2)
- a plastic bag containing the adapters and accessories (3)

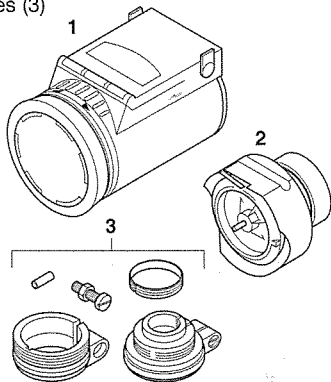

## 1. Inserting/replacing the batteries

- ▶ Turn the retainer tab up as far as possible and pull the control element off the valve attachment.
- ▶ Turn the battery clamp at the back of the control element anti-clockwise.

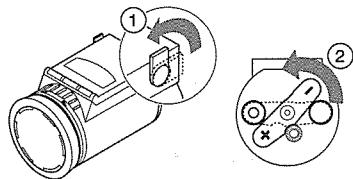

- ▶ Insert two alkaline manganese round cell batteries (type LR6 AA AM3). Ensure the polarity is correct! Incorrectly inserted or discharged batteries can damage the **Rondostat**.
- ▶ Turn the battery clamp back into place, pressing the batteries in gently at the same time.

New batteries have a lifetime of more than two years. The batteries need replacing when the display shows **BATT**. All settings are saved when the batteries are replaced.

- ▶ Dispose of old batteries in an environmentally friendly manner.

## 2. Setting the date and time

Once the batteries have been inserted or replaced, the **Rondostat** automatically requests that you enter date and time.

- ▶ Use the adjusting dial to set the year.
- ▶ Press the **PROG** button to confirm.
- ▶ Use the adjusting dial to set the month.
- ▶ Press the **PROG** button to confirm.
- ▶ Use the adjusting dial to set the day.
- ▶ Press the **PROG** button to confirm.
- ▶ Use the adjusting dial to set the hour.
- ▶ Press the **PROG** button to confirm.
- ▶ Use the adjusting dial to set the minute.
- ▶ Press the **PROG** button to confirm. That's all!

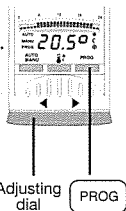

## 3. Mounting the regulator

You can mount the **Rondostat** easily on all standard radiator valves without causing any mess or water stains. You do not need to keep the old thermostat control knob:

- ▶ Release the fastening on the thermostat control knob.
- ▶ Pull the thermostat control knob off the valve.

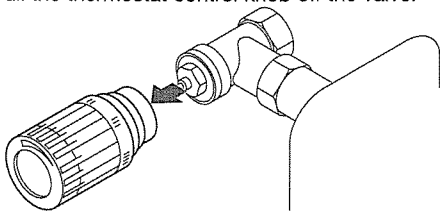

## Correcting the date and time

The **Rondostat** switches over automatically from summer to winter time. If, however, you want to correct the date and time during operation:

- ▶ Press and hold down the **PROG** button for 2 seconds
- ▶ Set the date and time as described above.

## 3.a Selecting an adapter

An adapter is required for some types of valve:

- ▶ Before installing the **Rondostat**, select a suitable adapter from the table of adapters.

If you need to use an adapter:

- ▶ Push the adapter onto the valve and turn it until you feel it click into place.
- ▶ If the valve is fitted with a screw, use the screw to secure the adapter.

### 3.b Mounting the valve attachment

- ▶ Turn the rotating wheel of the valve attachment anti-clockwise as far as possible.

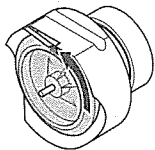

- ▶ Position the valve attachment on the valve or adapter. The flat surface must face upwards.

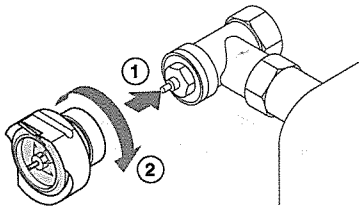

- ▶ Push in the knurled nut and tighten it securely by hand (do not use tools!).

### 3.c Attaching the control element

- ▶ Turn up the retainer tab on the control element.
- ▶ Push the control element onto the valve attachment and push it in as far as possible.

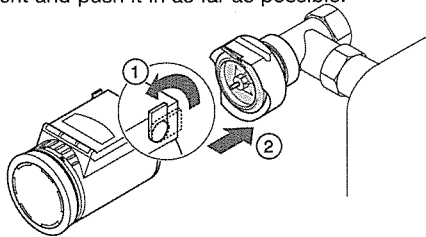

- ▶ Turn the retainer tab on the control element to the back.

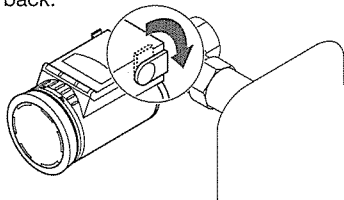

The **Rondostat** now adapts automatically to the valve. During adaptation, the display reads **AUTO AdAP**.  
**Your Rondostat is now ready for use with the factory settings!**

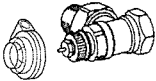
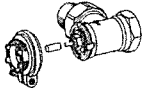
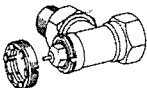

## Table of adapters

Manufacturer	Illustration	Adapter
Braukmann MNG (1974, 1975,...) Heimeier Junkers Landis & Gyr 'Duodyr'	-----	Not required
Danfoss RA		Supplied
Danfoss RAV		Supplied
Danfoss RAVL		Supplied

If you have any questions about mounting, operating or regulating the **Rondostat**, please call our Honeywell Hotline on +44-1344-656 000.

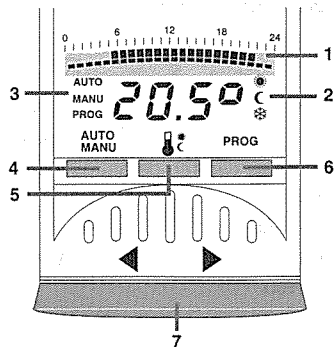
## The operating elements and display



- 1 Heating period or economy period in hours
- 2 Heating or economy temperature or frost protection
- 3 Operating mode Auto, Manu or Prog
- 4  button; Switching between automatic and manual operating modes
- 5  button; Setting the comfort and economy temperatures
- 6  button; Setting the timer program
- 7 Adjusting dial; Setting the temperature and time

## How does the Rondostat work?

### Temperatures and set times

The **Rondostat** differentiates between two temperatures:

- Comfort temperature ☀ (pre-set in factory to 21 °C)
- Economy temperature ☾ (pre-set in factory to 16 °C)

In automatic operating mode, the **Rondostat** alternates between these two temperatures in accordance with an adjustable timer program:

- Heating period: heating to comfort temperature
- Economy period: drops to economy temperature

### Timer program

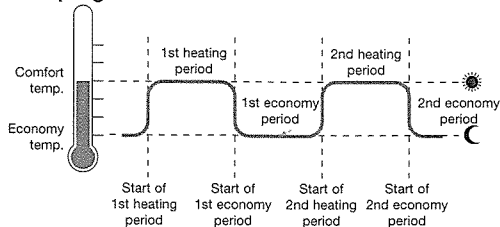

The heating and economy periods (the 2nd heating period is optional) are set in the freely adjustable timer program. The timer program is pre-set in the factory as follows:

- Start of the 1st heating period at 6:00
- Start of the 1st economy period at 22:00

## How to adjust the Rondostat

### Adjusting dial

You can use the adjusting dial to change the current room temperature at any time until the next heating or economy period begins.

### Adapting the Rondostat

If you want to change the **Rondostat** factory settings, proceed as follows:

- ▶ Set the comfort and economy temperatures.
- ▶ Make the same setting for all days. All the days of the week are set initially with the same heating and economy periods.
- ▶ Adjust each day of the week separately.

## Tips for operation

### Comfortable operation of the Rondostat

- ▶ Turn the retainer tab up and remove the control element for adjustment.
- ▶ When you have finished, push the control element on again and turn the retainer tab to the back.

### Lost your place in the program?

- ▶ Press the  button. The **Rondostat** ignores the last entry you made and returns to automatic operating mode.







## Setting the timer program

In the timer program, you can set 2 heating and 2 economy periods for every day of the week. The days of the week are numbered from 1 to 7 (Monday to Sunday) in the timer program.

### How to set the timer program:



- ▶ Press the  button.
- ▶ To make the same setting for all the days of the week: select 1 - 7 with the adjusting dial.

**Or** to make separate settings for each day of the week: use the adjusting dial to select the day you want.

- ▶ Press the  button to confirm your selection.
- ▶ Use the adjusting dial to set the start of the 1st heating period.
- ▶ Press the  button to confirm.
- ▶ Use the adjusting dial to set the start of the 1st economy period.
- ▶ Press the  button to confirm.
- ▶ Use the adjusting dial to set the start of the 2nd heating period.
- ▶ Press the  button to confirm.
- ▶ Use the adjusting dial to set the start of the 2nd economy period.
- ▶ Press the  button to confirm.
- ▶ Press the  button to end the procedure.

**Or** select the next day of the week and adjust the settings.

## Setting the comfort and economy temperatures





- ▶ Press the  button.
- ▶ Use the adjusting dial to adjust the comfort temperature.
- ▶ Press the  button.
- ▶ Use the adjusting dial to adjust the comfort temperature.
- ▶ Press the  button to confirm the change. That's all!

## Deleting a heating period

You can delete the 1st or 2nd heating period for one day of the week or for all the days of the week at once.

- ▶ Press the  button.
- ▶ To make the same setting for all the days of the week: select 1 - 7 with the adjusting dial.

**Or** to make separate settings for each day of the week: use the adjusting dial to select the day you want.

- ▶ Press the  button to confirm your selection.
- ▶ Press the  button until the heating period you want to delete appears.
- ▶ Turn the adjusting dial until the display reads - - . - -
- ▶ Press the  button to confirm.
- ▶ Press the  button to end the procedure.

**Or** select the next day of the week and adjust the settings.



## Other settings

### Constant temperature without timer program (holidays)

- ▶ Press the  button to switch to manual operating mode.
- ▶ Use the adjusting dial to set the temperature. This temperature is maintained until you return to automatic operating mode.



### Heating break

If you have switched off the heating in the summer and want to save the Rondostat battery power:

- ▶ Press the  button to switch to manual operating mode.
- ▶ Turn the adjusting dial to the right until the message  appears on the display. The valve now stays open and the **Rondostat** switches off.

### Child lock

You can lock the **Rondostat** to prevent it being tampered with:

- ▶ Press the  and the  button together for 2 seconds. The message  appears on the display.

Use the same combination of buttons to free the **Rondostat** for operation again.

## The Rondostat is always alert!

### Window function

If you open a window and this causes the temperature to drop dramatically, the **Rondostat** shuts the radiator valve to save energy.

The message  appears on the display.

The **Rondostat** opens the valve again when the temperature rises again, or at the latest after 48 minutes. You can open the valve sooner, if you wish, by pressing the  button.



### Lime-scale protection

Every Saturday morning, the **Rondostat** automatically opens and closes the radiator valve, which prevents lime-scale deposits building up (Display: .

### Frost protection

If the temperature drops below 6°C, the **Rondostat** opens the radiator valve until the temperature rises above 8°C again. In this way, the **Rondostat** ensures that the radiator does not freeze.

## Closing the radiator valve

- ▶ Press the  button to switch to manual operating mode.
- ▶ Turn the adjusting dial to the left until the message  appears on the display. Frost protection is now guaranteed.



## Help with problems

Problem/Display	Cause	Solution
Radiator will not cool down.	Valve does not close fully.	Check installation and adapt manually if necessary.
AdAP	Display during self-adaptation.	Self-adaptation lasts for max. 3 minutes.
BaTT	The battery power is too low.	Replace the batteries as soon as possible.
E1	Adaptation not possible.	Check installation.
E2	Control element is not pushed on correctly.	Push on control element correctly.
E3	Motor cannot be moved.	Check installation, clean if necessary.

### Manual adaptation

- ▶ Release and remove the control element.
- ▶ Turn the adjusting dial in the valve attachment clockwise until the valve is closed.
- ▶ Press the  button and hold it down.
- ▶ Push the control element onto the valve attachment as far as it goes and lock it in place. The **Rondostat** confirms manual adaptation with **MANU AdAP** on the display.

### Emergency operation if batteries are run down

- ▶ Release and remove the control element.
- ▶ Operate the radiator valve manually with the adjusting dial in the valve attachment.

## Help with problems

**NOTE: IF YOU EXPERIENCE A PROBLEM WITH YOUR RONDOSTAT PLEASE SEE WARRANTY FOR INSTRUCTIONS. PLEASE DO NOT ATTEMPT TO REPAIR THE RONDOSTAT YOURSELF. DOING SO WILL VOID THE WARRANTY AND COULD CAUSE DAMAGE OR PERSONAL INJURY.**