

Datenblatt | Artikelnummer: 281-683

3-Leiter-Trennklemme; für Tragschiene 35 x 15 und 35 x 7,5; 4 mm²; CAGE CLAMP®

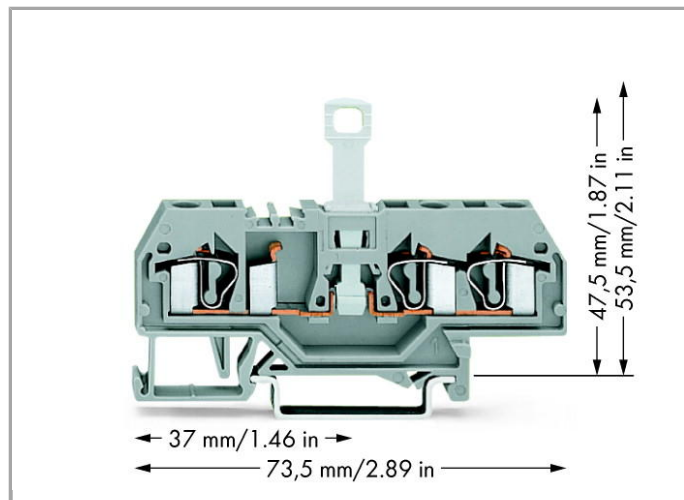

www.wago.com/281-683

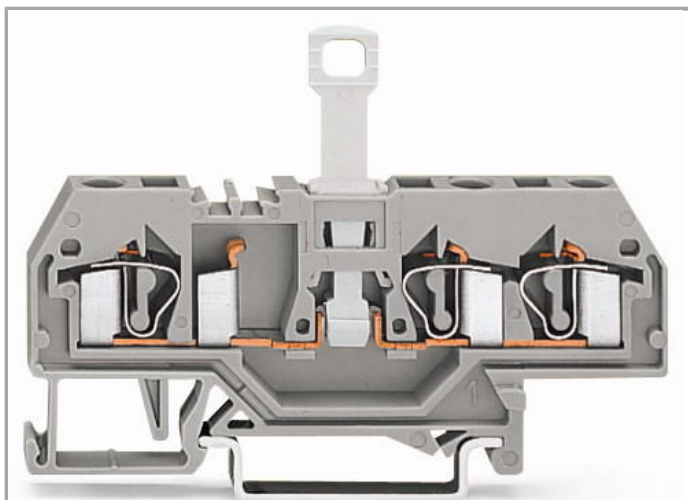

RoHS Compliant

[BOMcheck.net](https://www.bomcheck.net)

Farbe: ■

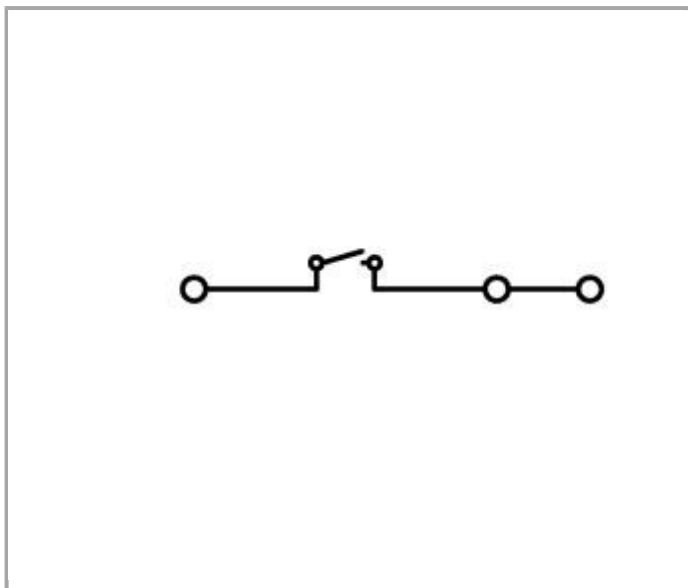

Daten
Elektrische Daten

Bemessungsdaten gemäß IEC/EN 60664-1

Bemessungsspannung (III / 3)	400 V
Bemessungsstoßspannung (III / 3)	6 kV
Bemessungsstrom	10 A
Legende Bemessungsdaten	(III / 3) \triangleq Überspannungskategorie III / Verschmutzungsgrad 3

Anschlussdaten

Anschlusstechnik	CAGE CLAMP®
Betätigungsart	Betätigungswerkzeug
Anschließbare Leiterwerkstoffe	Kupfer Aluminium
Eindrähtiger Leiter	0,08 ... 4 mm ² / 28 ... 12 AWG
Feindrähtiger Leiter	0,08 ... 4 mm ² / 28 ... 12 AWG
Abisolierlänge	9 ... 10 mm / 0.35 ... 0.39 inch
Gesamte Anzahl der Klemmstellen	3
Gesamte Anzahl der Potentiale	2
Anzahl der Ebenen	1
Verdrahtungsart	Frontverdrahtung

Geometrische Daten

Breite	6 mm / 0.236 inch
Höhe ab Oberkante Tragschiene	53,5 mm / 2.106 inch
Tiefe	73,5 mm / 2.894 inch

Mechanische Daten

Bauform	horizontale Bauform
Montageart	Tragschiene 35
Beschriftungsebene	Mittenbeschriftung

Werkstoffdaten

Farbe	grau
Isolierwerkstoff	Polyamid 66 (PA 66)
Brandlast	0.191 MJ
Gewicht	11.515 g



Kaufmännische Daten

Ursprungsland	DE
GTIN	4044918632027

Zolltarifnummer	85365080990
Produktgruppe	1 (Reihenklennen)
eCl@ss 9.0	27-14-11-26
eCl@ss 8.0	27-14-11-26
ETIM 6.0	EC000902
ETIM 5.0	EC000902

Zulassungen / Zertifikate

Länderspezifische Zulassungen



Logo	Zulassung	Zertifikatsname
	CCA DEKRA Certification B.V.	NTR NL-7454/A1
	CCA DEKRA Certification B.V.	NTR NL-7454/A1
	CSA DEKRA Certification B.V.	1505034
	CSA DEKRA Certification B.V.	1505034











Schiff Zulassungen

Logo	Zulassung	Zertifikatsname
	ABS American Bureau of Shipping	14-HG1293677-PDA
	BV Bureau Veritas S.A.	07436/E0 BV
	LR Lloyds Register	91/20112 (E9)

Passende Produkte

Tragschiene



	Art-Nr.: 210-112 Stahltragschiene; 35 x 7,5 mm; 1 mm dick; 2 m lang; gelocht; entsprechend EN 60715; Lochbreite 25 mm; Lochabstand 36 mm	www.wago.com/210-112
	Art-Nr.: 210-113 Stahltragschiene; 35 x 7,5 mm; 1 mm dick; 2 m lang; ungelocht; entsprechend EN 60715	www.wago.com/210-113

	Art-Nr.: 210-114 Stahltragschiene; 35 x 15 mm; 1,5 mm dick; 2 m lang; ungelocht; ähnlich EN 60715	www.wago.com/210-114
	Art-Nr.: 210-115 Stahltragschiene; 35 x 7,5 mm; 1 mm dick; 2 m lang; gelocht; entsprechend EN 60715; Lochbreite 18 mm; Lochabstand 25 mm	www.wago.com/210-115
	Art-Nr.: 210-118 Stahltragschiene; 35 x 15 mm; 2,3 mm dick; 2 m lang; ungelocht; entsprechend EN 60715	www.wago.com/210-118
	Art-Nr.: 210-196 Aluminiumtragschiene; 35 x 8,2 mm; 1,6 mm dick; 2 m lang; ungelocht; ähnlich EN 60715	www.wago.com/210-196
	Art-Nr.: 210-197 Stahltragschiene; 35 x 15 mm; 1,5 mm dick; 2 m lang; gelocht; ähnlich EN 60715	www.wago.com/210-197
	Art-Nr.: 210-198 Kupfertragschiene; 35 x 15 mm; 2,3 mm dick; 2 m lang; ungelocht; entsprechend EN 60715	www.wago.com/210-198
	Art-Nr.: 210-504 Stahltragschiene; 35 x 7,5 mm; 1 mm dick; 2 m lang; gelocht; bandverzinkt; entsprechend EN 60715	www.wago.com/210-504
	Art-Nr.: 210-505 Stahltragschiene; 35 x 7,5 mm; 1 mm dick; 2 m lang; ungelocht; bandverzinkt; entsprechend EN 60715	www.wago.com/210-505
	Art-Nr.: 210-506 Stahltragschiene; 35 x 15 mm; 1,5 mm dick; 2 m lang; ungelocht; bandverzinkt; ähnlich EN 60715	www.wago.com/210-506
	Art-Nr.: 210-508 Stahltragschiene; 35 x 15 mm; 1,5 mm dick; 2 m lang; gelocht; bandverzinkt; ähnlich EN 60715	www.wago.com/210-508



Warnabdeckung

	Art-Nr.: 281-415 Warnabdeckung; mit schwarzem Blitzpfeil; für 5 Klemmen	www.wago.com/281-415
--	---	--

Montage















	Art-Nr.: 209-106 Haltebock; zur isolierten Montage von Tragschienen DIN 35	www.wago.com/209-106
	Art-Nr.: 709-153 Abdeckprofil; Typ 1; passend zu Abdeckprofilträger Typ 1; 1 m lang	www.wago.com/709-153

Isolierungs-Stopp

	Art-Nr.: 281-470 Isolierungsstopp; 0,08 - 0,2 mm ² "e" (0,14 mm ² "f"); 5 Stück / Strang	www.wago.com/281-470
	Art-Nr.: 281-471 Isolierungsstopp; 0,25 - 0,5 mm ² ; 5 Stück / Strang	www.wago.com/281-471
	Art-Nr.: 281-472 Isolierungsstopp; 0,75 - 1,5 mm ² ; 5 Stück / Strang	www.wago.com/281-472

Beschriftungsmaterial

Art-Nr.: 2009-115

	WMB-Inline; für smartPRINTER; auf Rolle; dehnbar 5 - 5,2 mm; unbedruckt; aufrastbar	www.wago.com/2009-115
	Art-Nr.: 2009-115/000-002 WMB-Inline; für smartPRINTER; auf Rolle; dehnbar 5 - 5,2 mm; unbedruckt; aufrastbar	www.wago.com/2009-115/000-002
	Art-Nr.: 2009-115/000-006 WMB-Inline; für smartPRINTER; auf Rolle; dehnbar 5 - 5,2 mm; unbedruckt; aufrastbar	www.wago.com/2009-115/000-006
	Art-Nr.: 2009-115/000-007 WMB-Inline; für smartPRINTER; auf Rolle; dehnbar 5 - 5,2 mm; unbedruckt; aufrastbar	www.wago.com/2009-115/000-007
	Art-Nr.: 2009-115/000-012 WMB-Inline; für smartPRINTER; auf Rolle; dehnbar 5 - 5,2 mm; unbedruckt; aufrastbar	www.wago.com/2009-115/000-012
	Art-Nr.: 2009-115/000-017 WMB-Inline; für smartPRINTER; auf Rolle; dehnbar 5 - 5,2 mm; unbedruckt; aufrastbar	www.wago.com/2009-115/000-017
	Art-Nr.: 2009-115/000-023 WMB-Inline; für smartPRINTER; auf Rolle; dehnbar 5 - 5,2 mm; unbedruckt; aufrastbar	www.wago.com/2009-115/000-023
	Art-Nr.: 2009-115/000-024 WMB-Inline; für smartPRINTER; auf Rolle; dehnbar 5 - 5,2 mm; unbedruckt; aufrastbar	www.wago.com/2009-115/000-024
	Art-Nr.: 793-501 WMB-Beschriftungskarte; als Karte; nicht dehnbar; unbedruckt; aufrastbar	www.wago.com/793-501
	Art-Nr.: 793-501/000-002 WMB-Beschriftungskarte; als Karte; nicht dehnbar; unbedruckt; aufrastbar	www.wago.com/793-501/000-002
	Art-Nr.: 793-501/000-005 WMB-Beschriftungskarte; als Karte; nicht dehnbar; unbedruckt; aufrastbar	www.wago.com/793-501/000-005
	Art-Nr.: 793-501/000-006 WMB-Beschriftungskarte; als Karte; nicht dehnbar; unbedruckt; aufrastbar	www.wago.com/793-501/000-006
	Art-Nr.: 793-501/000-007 WMB-Beschriftungskarte; als Karte; nicht dehnbar; unbedruckt; aufrastbar	www.wago.com/793-501/000-007
	Art-Nr.: 793-501/000-012 WMB-Beschriftungskarte; als Karte; nicht dehnbar; unbedruckt; aufrastbar	www.wago.com/793-501/000-012
	Art-Nr.: 793-501/000-017 WMB-Beschriftungskarte; als Karte; nicht dehnbar; unbedruckt; aufrastbar	www.wago.com/793-501/000-017



Art-Nr.: 793-501/000-023
WMB-Beschriftungskarte; als Karte; nicht dehnbar; unbedruckt; aufrastbar

www.wago.com/793-501/000-023



Art-Nr.: 793-501/000-024
WMB-Beschriftungskarte; als Karte; nicht dehnbar; unbedruckt; aufrastbar

www.wago.com/793-501/000-024



Art-Nr.: 793-5501
WMB-Beschriftungskarte; als Karte; für Klemmenbreite 5 - 17,5 mm; dehnbar 5 - 5,2 mm; unbedruckt; aufrastbar

www.wago.com/793-5501



Art-Nr.: 793-5501/000-002
WMB-Beschriftungskarte; als Karte; für Klemmenbreite 5 - 17,5 mm; dehnbar 5 - 5,2 mm; unbedruckt; aufrastbar

www.wago.com/793-5501/000-002



Art-Nr.: 793-5501/000-005
WMB-Beschriftungskarte; als Karte; dehnbar 5 - 5,2 mm; unbedruckt; aufrastbar

www.wago.com/793-5501/000-005



Art-Nr.: 793-5501/000-006
WMB-Beschriftungskarte; als Karte; dehnbar 5 - 5,2 mm; unbedruckt; aufrastbar

www.wago.com/793-5501/000-006



Art-Nr.: 793-5501/000-007
WMB-Beschriftungskarte; als Karte; dehnbar 5 - 5,2 mm; unbedruckt; aufrastbar

www.wago.com/793-5501/000-007



Art-Nr.: 793-5501/000-012
WMB-Beschriftungskarte; als Karte; dehnbar 5 - 5,2 mm; unbedruckt; aufrastbar

www.wago.com/793-5501/000-012



Art-Nr.: 793-5501/000-017
WMB-Beschriftungskarte; als Karte; dehnbar 5 - 5,2 mm; unbedruckt; aufrastbar

www.wago.com/793-5501/000-017



Art-Nr.: 793-5501/000-023
WMB-Beschriftungskarte; als Karte; dehnbar 5 - 5,2 mm; unbedruckt; aufrastbar

www.wago.com/793-5501/000-023



Art-Nr.: 793-5501/000-024
WMB-Beschriftungskarte; als Karte; dehnbar 5 - 5,2 mm; unbedruckt; aufrastbar

www.wago.com/793-5501/000-024

Aderendhülse



Art-Nr.: 216-106
Aderendhülse; Hülse für 2,5 mm² / AWG 14; ohne Kunststoffkragen; galvanisch verzinkt

www.wago.com/216-106



Art-Nr.: 216-201
Aderendhülse; Hülse für 0,5 mm² / AWG 22; mit Kunststoffkragen; galvanisch verzinkt

www.wago.com/216-201









Art-Nr.: 216-202
Aderendhülse; Hülse für 0,75 mm² / AWG 20; mit Kunststoffkragen; galvanisch verzinkt

www.wago.com/216-202







Art-Nr.: 216-203
Aderendhülse; Hülse für 1 mm² / AWG 18; mit Kunststoffkragen; galvanisch verzinkt



www.wago.com/216-203

	Art-Nr.: 216-204 Aderendhülse; Hülse für 1,5 mm ² / AWG 16; mit Kunststoffkragen; galvanisch verzinkt	www.wago.com/216-204
	Art-Nr.: 216-205 Aderendhülse; Hülse für 2,08 mm ² / AWG 14; mit Kunststoffkragen; galvanisch verzinkt	www.wago.com/216-205
	Art-Nr.: 216-206 Aderendhülse; Hülse für 2,5 mm ² / AWG 14; mit Kunststoffkragen; galvanisch verzinkt	www.wago.com/216-206
	Art-Nr.: 216-241 Aderendhülse; Hülse für 0,5 mm ² / AWG 22; mit Kunststoffkragen; galvanisch verzinkt; Elektrolytkupfer; gasdicht aufgecrimpt; gemäß DIN 46228, Teil 4/09.90	www.wago.com/216-241
	Art-Nr.: 216-242 Aderendhülse; Hülse für 0,75 mm ² / AWG 20; mit Kunststoffkragen; galvanisch verzinkt; Elektrolytkupfer; gasdicht aufgecrimpt; gemäß DIN 46228, Teil 4/09.90	www.wago.com/216-242
	Art-Nr.: 216-243 Aderendhülse; Hülse für 1 mm ² / AWG 18; mit Kunststoffkragen; galvanisch verzinkt; Elektrolytkupfer; gasdicht aufgecrimpt; gemäß DIN 46228, Teil 4/09.90	www.wago.com/216-243
	Art-Nr.: 216-244 Aderendhülse; Hülse für 1,5 mm ² / AWG 16; mit Kunststoffkragen; galvanisch verzinkt; Elektrolytkupfer; gasdicht aufgecrimpt; gemäß DIN 46228, Teil 4/09.90	www.wago.com/216-244
	Art-Nr.: 216-246 Aderendhülse; Hülse für 2,5 mm ² / AWG 14; mit Kunststoffkragen; galvanisch verzinkt; Elektrolytkupfer; gasdicht aufgecrimpt; gemäß DIN 46228, Teil 4/09.90	www.wago.com/216-246
	Art-Nr.: 216-301 Aderendhülse; Hülse für 0,25 mm ² / AWG 24; mit Kunststoffkragen; galvanisch verzinkt	www.wago.com/216-301
	Art-Nr.: 216-302 Aderendhülse; Hülse für 0,34 mm ² / AWG 24; mit Kunststoffkragen; galvanisch verzinkt	www.wago.com/216-302

Abschlussplatte



	Art-Nr.: 281-324 Abschluss- und Zwischenplatte; 2,5 mm dick	www.wago.com/281-324
	Art-Nr.: 281-326 Abschluss- und Zwischenplatte; 2,5 mm dick	www.wago.com/281-326
	Art-Nr.: 281-344 Trennwand; 2 mm dick; überstehend	www.wago.com/281-344
	Art-Nr.: 281-346 Trennwand; 2 mm dick; überstehend	www.wago.com/281-346

Allgemeines Zubehör





	Art-Nr.: 209-107 Prüfbuchse; isoliert; Ø 2 mm	www.wago.com/209-107
	Art-Nr.: 209-108 Prüfbuchse; isoliert; Ø 2,3 mm	www.wago.com/209-108
	Art-Nr.: 249-105 Gruppenschildträger	www.wago.com/249-105
	Art-Nr.: 709-170 Einschaltperre; für Trennstöpsel der Trennklemmen der Serien 280/281 und 769	www.wago.com/709-170

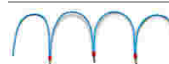

Werkzeug

	Art-Nr.: 210-657 Betätigungswerkzeug mit teilisoliertem Schaft; Klinge (3,5 x 0,5) mm; kurz	www.wago.com/210-657
	Art-Nr.: 210-658 Betätigungswerkzeug mit teilisoliertem Schaft; Klinge (3,5 x 0,5) mm; kurz; abgewinkelt	www.wago.com/210-658
	Art-Nr.: 210-720 Betätigungswerkzeug mit teilisoliertem Schaft; Typ 2, Klinge (3,5 x 0,5) mm	www.wago.com/210-720

Brücker

	Art-Nr.: 210-103 Drahtkettenbrücke; isoliert; 50 Anschlüsse	www.wago.com/210-103
	Art-Nr.: 210-123 Drahtkettenbrücke; isoliert; 50 Anschlüsse	www.wago.com/210-123
	Art-Nr.: 281-482 Brückungskamm; isoliert; 2-fach; IN = IN Klemme	www.wago.com/281-482
	Art-Nr.: 281-483 Brückungskamm; isoliert; 3-fach; IN = IN Klemme	www.wago.com/281-483
	Art-Nr.: 281-485 Brückungskamm; isoliert; 5-fach; IN = IN Klemme	www.wago.com/281-485
	Art-Nr.: 281-490 Brückungskamm; isoliert; 10-fach; IN = IN Klemme	www.wago.com/281-490
	Art-Nr.: 281-492 Doppelteilungsbrückungskamm; isoliert; 2-fach; IN = IN Klemme	www.wago.com/281-492
	Art-Nr.: 709-110 Drahtkettenbrücke; isoliert; 4 Anschlüsse; 3 x 110 mm	www.wago.com/709-110
	Art-Nr.: 709-111 Drahtkettenbrücke; isoliert; 3 Anschlüsse; 2 x 120 mm	www.wago.com/709-111
	Art-Nr.: 709-112 Drahtkettenbrücke; isoliert; 3 Anschlüsse; 2 x 170 mm	www.wago.com/709-112
	Art-Nr.: 781-455 Schachtelbrücker; isoliert; von 1 auf 5; Teilung 6 mm	www.wago.com/781-455

Prüfen und Messen

	Art-Nr.: 210-136 Prüfstecker; Ø 2 mm; mit 500mm-Leitung	www.wago.com/210-136
	Art-Nr.: 210-137 Prüfstecker; Ø 2,3 mm; mit 500mm-Leitung	www.wago.com/210-137



Downloads

Dokumentation

Ausschreibungstext

281-683	Oct 12, 2017	DOC 24,6 kB	Download
---------	--------------	----------------	----------

smartDATA

CAD Daten

3D Download 281-683	URL	Download
---------------------	-----	----------

Änderungen vorbehalten.

WAGO Kontakttechnik GmbH & Co. KG
Hansastr. 27
32423 Minden
Telefon: +49571 887-0
E-Mail: info.de@wago.com | Web: www.wago.com

Haben Sie Fragen zu unseren Produkten?
Wir stehen Ihnen telefonisch unter +49 (571) 887-44222 gern zur
Verfügung.