

Datenblatt | Artikelnummer: 279-994

4-Leiter-Durchgangsklemme; 1,5 mm²; für Anwendungen Ex e II geeignet;
mittige Beschriftung; für Tragschiene 35 x 15 und 35 x 7,5; CAGE CLAMP®

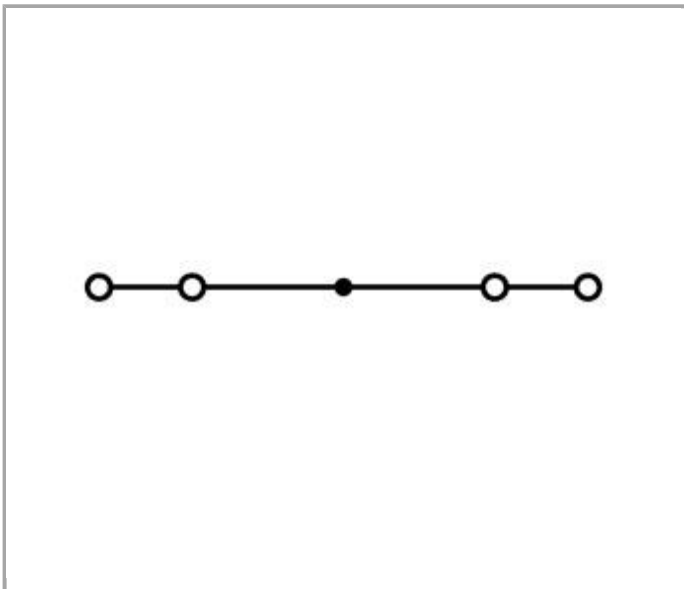

www.wago.com/279-994

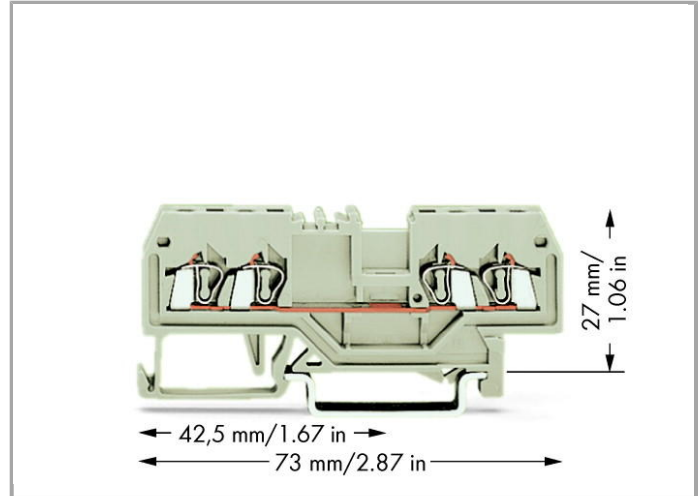
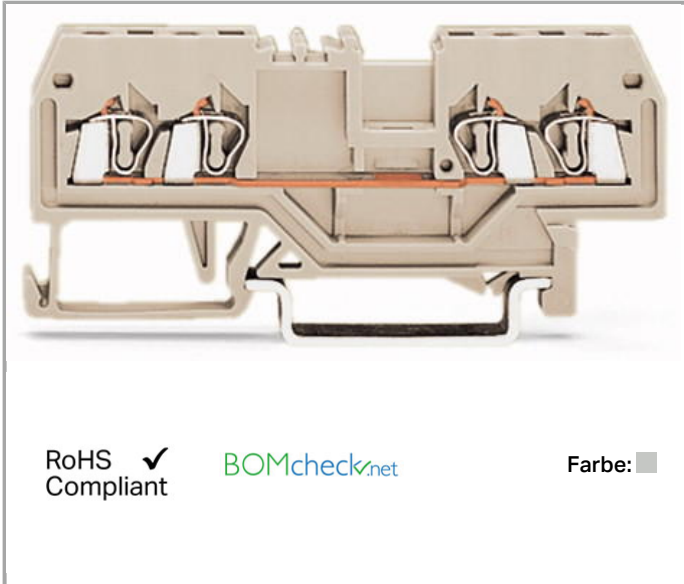

Daten

Elektrische Daten

Bemessungsspannung EN (Ex e II)

550 V

Bemessungsdaten gemäß IEC/EN 60664-1

Bemessungsstrom

15 A

Anschlussdaten

Anschluss technik	CAGE CLAMP®
Betätigungsart	Betätigungswerkzeug
Anschließbare Leiterwerkstoffe	Kupfer Aluminium
Eindrähtiger Leiter	0,08 ... 1,5 mm ² / 28 ... 16 AWG
Feindrähtiger Leiter	0,08 ... 1,5 mm ² / 28 ... 16 AWG
Abisolierlänge	8 ... 9 mm / 0.31 ... 0.35 inch
Gesamte Anzahl der Klemmstellen	4
Gesamte Anzahl der Potentiale	1
Anzahl der Ebenen	1
Verdrahtungsart	Frontverdrahtung

Geometrische Daten

Breite	4 mm / 0.157 inch
Höhe ab Oberkante Tragschiene	27 mm / 1.063 inch
Tiefe	73 mm / 2.874 inch

Mechanische Daten

Bauform	horizontale Bauform
Montageart	Tragschiene 35
Beschriftungsebene	Mittenbeschriftung

Werkstoffdaten

Farbe	lichtgrau
Isolierwerkstoff	Polyamid 66 (PA 66)
Brandlast	0.116 MJ
Gewicht	6.31 g

Kaufmännische Daten

Ursprungsland	DE
GTIN	4044918520683
Zolltarifnummer	85369010000
eCl@ss 9.0	27-14-11-20
eCl@ss 8.0	27-14-11-20
ETIM 6.0	EC000897
ETIM 5.0	EC000897

Zulassungen / Zertifikate



Ex-Zulassungen

Logo	Zulassung	Zertifikatsname
	AEx UL International Germany GmbH c/o Physikalisch Technische Bundesanstalt	E185892 Sec.15

Länderspezifische Zulassungen

Logo	Zulassung	Zertifikatsname
	CCA DEKRA Certification B.V.	NTR NL-7081
	KEMA/KEUR DEKRA Certification B.V.	2160584.04

Schiff Zulassungen



Logo	Zulassung	Zertifikatsname
	ABS American Bureau of Shipping	14-HG1293677-PDA
	LR Lloyds Register	91/20112 (E9)

















UL-Zulassungen

Logo	Zulassung	Zertifikatsname
	UR Underwriters Laboratories Inc.	E45172

Passende Produkte

Tragschiene

	Art-Nr.: 210-112 Stahltragschiene; 35 x 7,5 mm; 1 mm dick; 2 m lang; gelocht; entsprechend EN 60715; Lochbreite 25 mm; Lochabstand 36 mm	www.wago.com/210-112
	Art-Nr.: 210-113 Stahltragschiene; 35 x 7,5 mm; 1 mm dick; 2 m lang; ungelocht; entsprechend EN 60715	www.wago.com/210-113

	Art-Nr.: 210-114 Stahltragschiene; 35 x 15 mm; 1,5 mm dick; 2 m lang; ungelocht; ähnlich EN 60715	www.wago.com/210-114
	Art-Nr.: 210-115 Stahltragschiene; 35 x 7,5 mm; 1 mm dick; 2 m lang; gelocht; entsprechend EN 60715; Lochbreite 18 mm; Lochabstand 25 mm	www.wago.com/210-115
	Art-Nr.: 210-118 Stahltragschiene; 35 x 15 mm; 2,3 mm dick; 2 m lang; ungelocht; entsprechend EN 60715	www.wago.com/210-118
	Art-Nr.: 210-196 Aluminiumtragschiene; 35 x 8,2 mm; 1,6 mm dick; 2 m lang; ungelocht; ähnlich EN 60715	www.wago.com/210-196
	Art-Nr.: 210-197 Stahltragschiene; 35 x 15 mm; 1,5 mm dick; 2 m lang; gelocht; ähnlich EN 60715	www.wago.com/210-197
	Art-Nr.: 210-198 Kupfertragschiene; 35 x 15 mm; 2,3 mm dick; 2 m lang; ungelocht; entsprechend EN 60715	www.wago.com/210-198
	Art-Nr.: 210-504 Stahltragschiene; 35 x 7,5 mm; 1 mm dick; 2 m lang; gelocht; bandverzinkt; entsprechend EN 60715	www.wago.com/210-504
	Art-Nr.: 210-505 Stahltragschiene; 35 x 7,5 mm; 1 mm dick; 2 m lang; ungelocht; bandverzinkt; entsprechend EN 60715	www.wago.com/210-505
	Art-Nr.: 210-506 Stahltragschiene; 35 x 15 mm; 1,5 mm dick; 2 m lang; ungelocht; bandverzinkt; ähnlich EN 60715	www.wago.com/210-506
	Art-Nr.: 210-508 Stahltragschiene; 35 x 15 mm; 1,5 mm dick; 2 m lang; gelocht; bandverzinkt; ähnlich EN 60715	www.wago.com/210-508
Montage		
	Art-Nr.: 209-106 Haltebock; zur isolierten Montage von Tragschienen DIN 35	www.wago.com/209-106
	Art-Nr.: 709-153 Abdeckprofil; Typ 1; passend zu Abdeckprofilträger Typ 1; 1 m lang	www.wago.com/709-153
Abschlussplatte		
	Art-Nr.: 209-191 Trennwand Ex e/Ex i; 3 mm dick; 120 mm breit	www.wago.com/209-191
	Art-Nr.: 279-348 Abschluss- und Zwischenplatte; 2 mm dick	www.wago.com/279-348
	Art-Nr.: 279-349 Trennwand; 2 mm dick; überstehend	www.wago.com/279-349
Brücker		
	Art-Nr.: 210-103 Drahtkettenbrücke; isoliert; 50 Anschlüsse	www.wago.com/210-103
	Art-Nr.: 249-123 Steckbarer Leitungsbrücker; isoliert; L = 180 mm; Leitungsquerschnitt 0,75 mm ²	www.wago.com/249-123

	Art-Nr.: 249-125 Steckbarer Leitungsbrücker; isoliert; L = 60 mm; Leitungsquerschnitt 0,75 mm ²	www.wago.com/249-125
	Art-Nr.: 249-126 Steckbarer Leitungsbrücker; isoliert; L = 110 mm; Leitungsquerschnitt 0,75 mm ²	www.wago.com/249-126
	Art-Nr.: 249-127 Steckbarer Leitungsbrücker; isoliert; L = 250 mm; Leitungsquerschnitt 0,75 mm ²	www.wago.com/249-127
	Art-Nr.: 279-402 Querbrücker; isoliert; Nennstrom 15 A	www.wago.com/279-402
	Art-Nr.: 279-409 Doppelteilungsquerbrücker; isoliert; Nennstrom 15 A	www.wago.com/279-409
	Art-Nr.: 279-422 Querbrücker; isoliert; Nennstrom 15 A	www.wago.com/279-422
	Art-Nr.: 279-482 Brückungskamm; isoliert; 2-fach; IN = IN Klemme	www.wago.com/279-482
	Art-Nr.: 279-483 Brückungskamm; isoliert; 3-fach; IN = IN Klemme	www.wago.com/279-483
	Art-Nr.: 279-490 Brückungskamm; isoliert; 10-fach; IN = IN Klemme	www.wago.com/279-490
	Art-Nr.: 279-492 Doppelteilungsbrückungskamm; isoliert; 2-fach; IN = IN Klemme	www.wago.com/279-492

Aderendhülse

	Art-Nr.: 216-101 Aderendhülse; Hülse für 0,5 mm ² / AWG 22; ohne Kunststoffkragen; galvanisch verzinkt	www.wago.com/216-101
	Art-Nr.: 216-102 Aderendhülse; Hülse für 0,75 mm ² / AWG 20; ohne Kunststoffkragen; galvanisch verzinkt	www.wago.com/216-102
	Art-Nr.: 216-103 Aderendhülse; Hülse für 1 mm ² / AWG 18; ohne Kunststoffkragen; galvanisch verzinkt	www.wago.com/216-103
	Art-Nr.: 216-201 Aderendhülse; Hülse für 0,5 mm ² / AWG 22; mit Kunststoffkragen; galvanisch verzinkt	www.wago.com/216-201
	Art-Nr.: 216-202 Aderendhülse; Hülse für 0,75 mm ² / AWG 20; mit Kunststoffkragen; galvanisch verzinkt	www.wago.com/216-202
	Art-Nr.: 216-203 Aderendhülse; Hülse für 1 mm ² / AWG 18; mit Kunststoffkragen; galvanisch verzinkt	www.wago.com/216-203
	Art-Nr.: 216-301 Aderendhülse; Hülse für 0,25 mm ² / AWG 24; mit Kunststoffkragen; galvanisch verzinkt	www.wago.com/216-301
	Art-Nr.: 216-302 Aderendhülse; Hülse für 0,34 mm ² / AWG 24; mit Kunststoffkragen; galvanisch verzinkt	www.wago.com/216-302

Werkzeug

Art-Nr.: 210-647

	Betätigungswerkzeug mit teilisoliertem Schaft; Klinge (2,5 x 0,4) mm; kurz	www.wago.com/210-647
--	--	--

	Art-Nr.: 210-648 Betätigungswerkzeug mit teilisoliertem Schaft; Klinge (2,5 x 0,4) mm; kurz; abgewinkelt	www.wago.com/210-648
--	--	--

	Art-Nr.: 210-719 Betätigungswerkzeug mit teilisoliertem Schaft; Typ 1, Klinge (2,5 x 0,4) mm	www.wago.com/210-719
--	--	--

Isolierungs-Stopp

	Art-Nr.: 279-470 Isolierungsstopp; 0,08 - 0,2 mm ² "e" (0,14 mm ² "f"); 5 Stück / Strang	www.wago.com/279-470
--	--	--

	Art-Nr.: 279-471 Isolierungsstopp; 0,25 mm ² ; 5 Stück / Strang	www.wago.com/279-471
--	--	--

Beschriftungsmaterial

	Art-Nr.: 2009-114 WMB-Inline; für smartPRINTER; auf Rolle; dehnbar 4 - 4,2 mm; unbedruckt; aufrastbar	www.wago.com/2009-114
--	---	--

	Art-Nr.: 2009-114/000-002 WMB-Inline; für smartPRINTER; auf Rolle; dehnbar 4 - 4,2 mm; unbedruckt; aufrastbar	www.wago.com/2009-114/000-002
--	---	--

	Art-Nr.: 2009-114/000-005 WMB-Inline; für smartPRINTER; auf Rolle; dehnbar 4 - 4,2 mm; unbedruckt; aufrastbar	www.wago.com/2009-114/000-005
---	---	--

	Art-Nr.: 2009-114/000-006 WMB-Inline; für smartPRINTER; auf Rolle; dehnbar 4 - 4,2 mm; unbedruckt; aufrastbar	www.wago.com/2009-114/000-006
--	---	--

	Art-Nr.: 2009-114/000-007 WMB-Inline; für smartPRINTER; auf Rolle; dehnbar 4 - 4,2 mm; unbedruckt; aufrastbar	www.wago.com/2009-114/000-007
--	---	--

	Art-Nr.: 2009-114/000-012 WMB-Inline; für smartPRINTER; auf Rolle; dehnbar 4 - 4,2 mm; unbedruckt; aufrastbar	www.wago.com/2009-114/000-012
--	---	--

	Art-Nr.: 2009-114/000-023 WMB-Inline; für smartPRINTER; auf Rolle; dehnbar 4 - 4,2 mm; unbedruckt; aufrastbar	www.wago.com/2009-114/000-023
--	---	--

	Art-Nr.: 2009-114/000-024 WMB-Inline; für smartPRINTER; auf Rolle; dehnbar 4 - 4,2 mm; unbedruckt; aufrastbar	www.wago.com/2009-114/000-024
--	---	--

	Art-Nr.: 209-128 Adapter	www.wago.com/209-128
--	------------------------------------	--

	Art-Nr.: 209-140 Gruppenschildträger	www.wago.com/209-140
--	--	--

	Art-Nr.: 209-141 Gruppenschildträger	www.wago.com/209-141
--	--	--



Art-Nr.: 209-142
Gruppenschildträger

www.wago.com/209-142



Art-Nr.: 209-185
Adapter

www.wago.com/209-185



Art-Nr.: 793-4501
WMB-Beschriftungskarte; als Karte; dehnbar 4 - 4,2 mm; unbedruckt; aufrastbar

www.wago.com/793-4501



Art-Nr.: 793-4501/000-002
WMB-Beschriftungskarte; als Karte; dehnbar 4 - 4,2 mm; unbedruckt; aufrastbar

www.wago.com/793-4501/000-002



Art-Nr.: 793-4501/000-005
WMB-Beschriftungskarte; als Karte; dehnbar 4 - 4,2 mm; unbedruckt; aufrastbar

www.wago.com/793-4501/000-005



Art-Nr.: 793-4501/000-006
WMB-Beschriftungskarte; als Karte; dehnbar 4 - 4,2 mm; unbedruckt; aufrastbar

www.wago.com/793-4501/000-006



Art-Nr.: 793-4501/000-007
WMB-Beschriftungskarte; als Karte; dehnbar 4 - 4,2 mm; unbedruckt; aufrastbar

www.wago.com/793-4501/000-007



Art-Nr.: 793-4501/000-012
WMB-Beschriftungskarte; als Karte; dehnbar 4 - 4,2 mm; unbedruckt; aufrastbar

www.wago.com/793-4501/000-012



Art-Nr.: 793-4501/000-017
WMB-Beschriftungskarte; als Karte; dehnbar 4 - 4,2 mm; unbedruckt; aufrastbar

www.wago.com/793-4501/000-017



Art-Nr.: 793-4501/000-023
WMB-Beschriftungskarte; als Karte; dehnbar 4 - 4,2 mm; unbedruckt; aufrastbar

www.wago.com/793-4501/000-023



Art-Nr.: 793-4501/000-024
WMB-Beschriftungskarte; als Karte; dehnbar 4 - 4,2 mm; unbedruckt; aufrastbar

www.wago.com/793-4501/000-024

Warnabdeckung



Art-Nr.: 279-415
Warnabdeckung; mit schwarzem Blitzpfeil; für 5 Klemmen

www.wago.com/279-415

Allgemeines Zubehör



Art-Nr.: 249-105
Gruppenschildträger

www.wago.com/249-105

Downloads

Dokumentation

Ausschreibungstext



279-994

Oct 12, 2017

DOC
24,1 kB

Download

smartDATA

CAD Daten

3D Download 279-994

URL

Download

Änderungen vorbehalten.

WAGO Kontakttechnik GmbH & Co. KG
Hansastr. 27
32423 Minden
Telefon: +49571 887-0
E-Mail: info.de@wago.com | Web: www.wago.com

Haben Sie Fragen zu unseren Produkten?
Wir stehen Ihnen telefonisch unter +49 (571) 887-44222 gern zur
Verfügung.