

Mini Push-Button Switches, Red

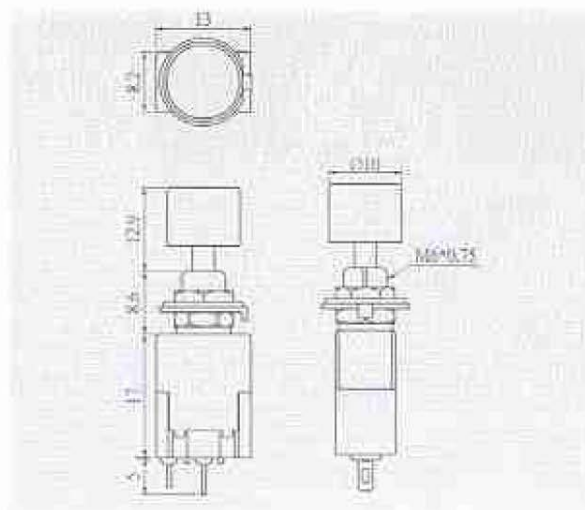









Rating	6A 125V AC 3A 250V AC
Contact resistance	50mΩ Max
Insulation resistant	DC 500V 100MΩ Min
Dielectric strength	AC 1000V 1 minute
Cut-out	

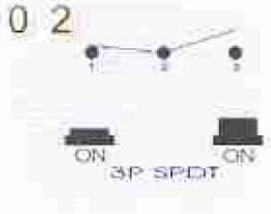

FEATURES

- * MATERIAL: Alkyd base (UL flame: 94V-0) for high insulation. Stainless steel cover for high corrosion resistant.
- * Contacts and Terminals are copper with silver alloy and silver plated.
- * Epoxy sealed for dust and moisture resistant.

FUNCTION	BUTTON	TERMINAL
<p>0 1</p>  <p>ON OFF 2P-SPST</p>	<p>A</p> 	<p>1  SO</p> <p>2  PC</p> <p>3  PC Angle(2.54)</p> <p>5  PC Angle(3.8)</p>
<p>0 2</p>  <p>ON ON 3P-SPDT</p>		
<p>0 6</p>  <p>ON ON 3P-SPDT</p>		

Fireproof: 94V-0
Protection Class: IP30

Unit: mm